

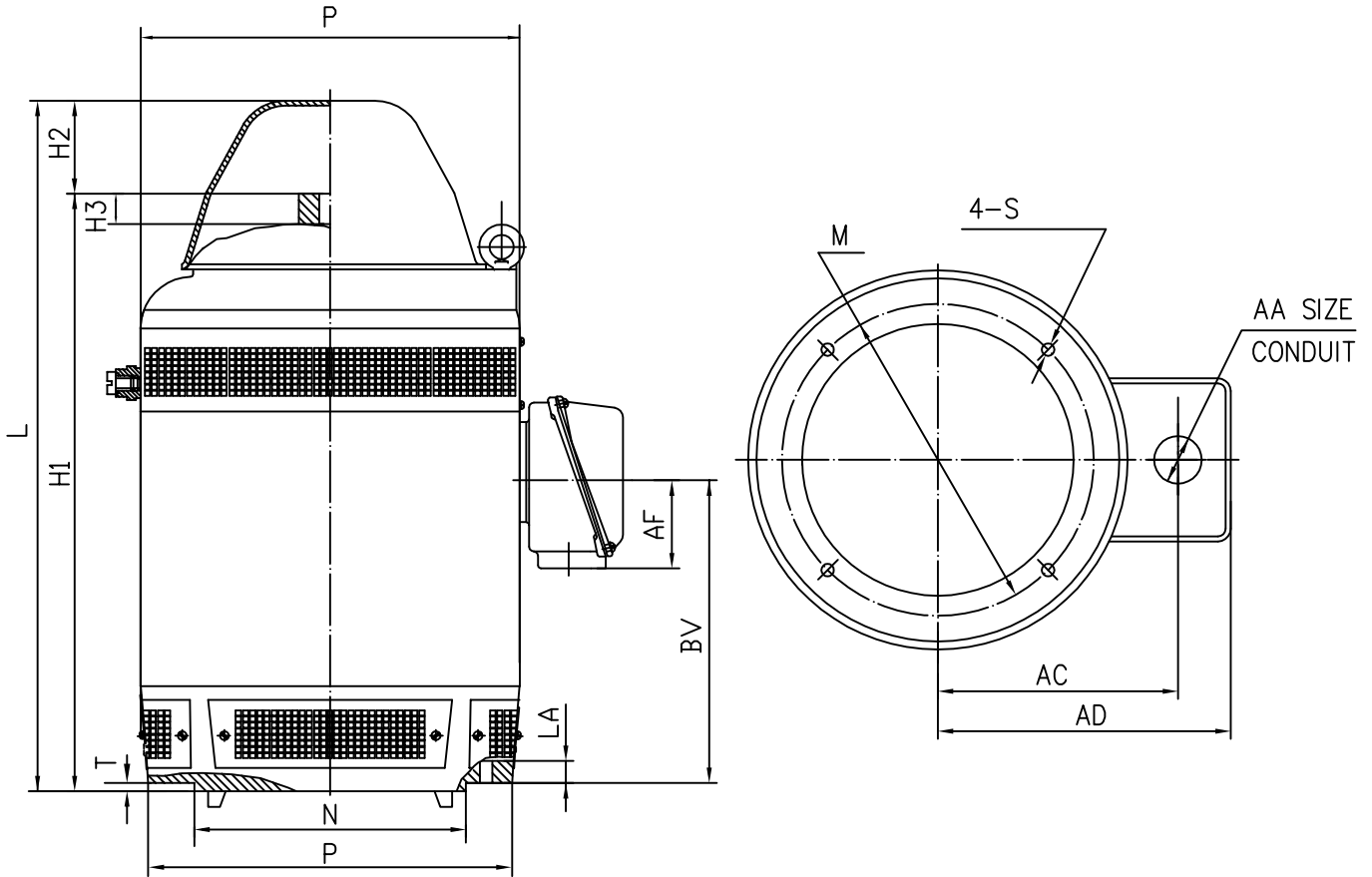

YLB THREE PHASE INDUCTION MOTORS
FRAME: 160 IP23 HIGH THRUST

PRINT: **XD1-1-01A**

SHEET: **1 OF 1**



UNITS	H1	H2>	H3	M	N	P	S	T	L
MM	717	80	53	267	235	325	15	5	850

CONDUIT BOX MATERIAL	UNITS	AA	AD	AC	BV	AF
CAST IRON	MM	M36	260	196	308	128