



YLB THREE PHASE INDUCTION MOTORS

FRAME: 200 IP23 HIGH THRUST

PRINT: XD1-1-03C

SHEET: 1 OF 1

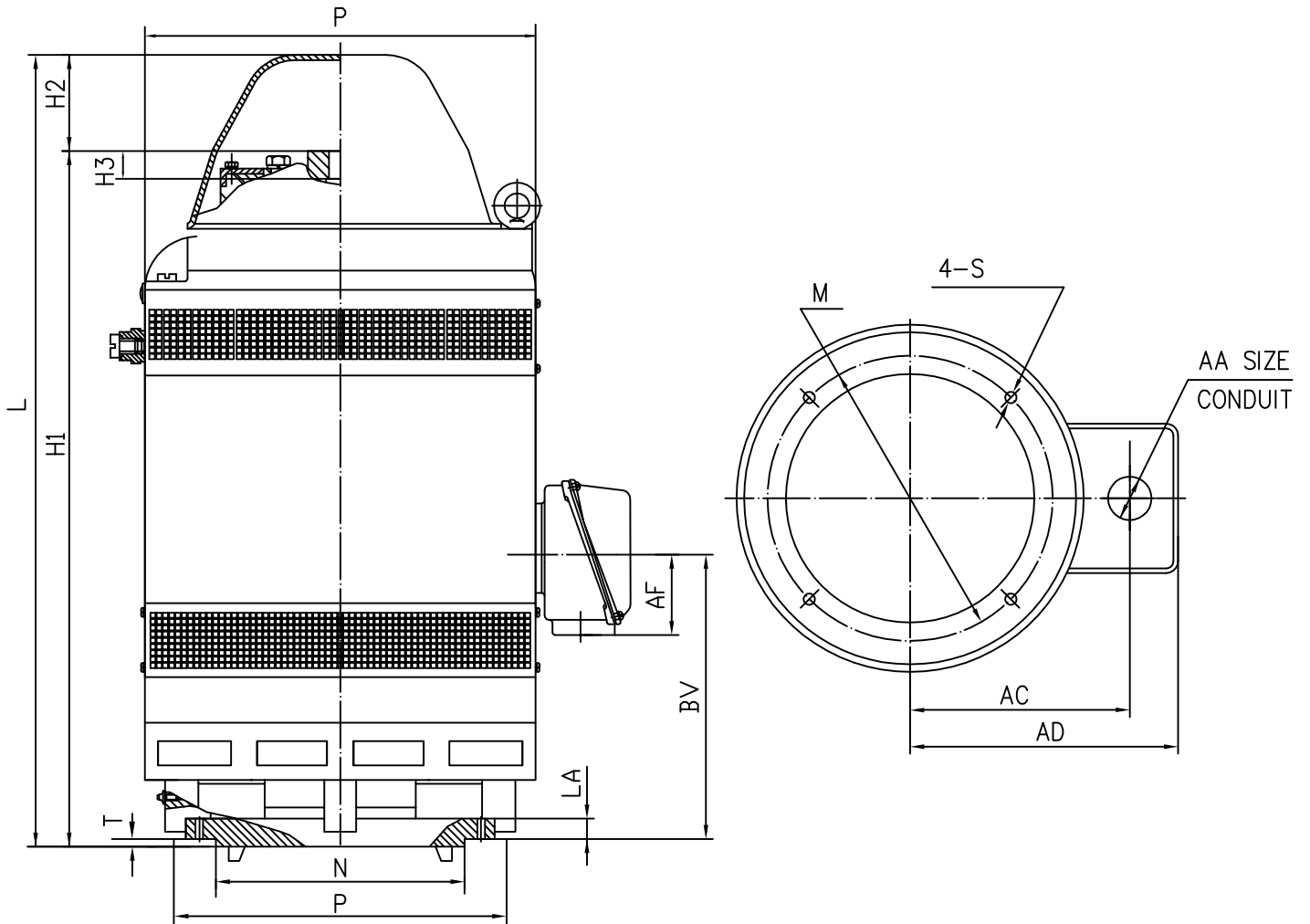

UNITS	H1	H2>	H3	M	N	P	S	T	L
MM	851	95	70	370	330	420	19	5	995

CONDUIT BOX MATERIAL	UNITS	AA	AD	AC	BV	AF
CAST IRON	MM	M48	349	279	390	150